

D Series



**ESA S530
CNC Control Unit**
7" Color
2D Graphic Screen

Standard Features

1. Y1,Y2,X,R CNC 4 Axes (X + R Servo)
2. **410mm Stroke, 510mm Throat** Depth
3. **ESA S650** CNC Control Unit
4. $\pm 0,03$ accuracy SERVO motorized back gauge. X=750mm, R=250mm
5. Quick clamp Promecam punch tool holder
6. **Sliding front sheet support arms with hand Wheel**
7. **Motorized Anti-deflection crowning** with original Wila wedges.
8. MVD special narrow bottom table (European type)
9. GIVI optic linear scales
10. Standard punch tools (H: 67, 85°, R:08)
11. Standard die tools (60x60mm, 4 Vee V=16-22-35-50mm, 85°, H:60)
12. LED illumination on RAM

Optional Features

1. X + R to 4-6-8 axis back gauge options
2. Rolleri Rol200 hydraulic punch clamping
3. Wila hydraulic punch clamping
4. Wide bottom table for Multi Vee dies.
5. 1.000mm X axis travel
6. AKAS or DSP front laser safety systems
7. Additional back gauge fingers
8. Front laser safety



Standard

Sliding front support arms



Standard

Motorized Crowning

B-Series - Technical Specifications

D Bending Force	Bending Length	Distance between columns	Stroke	Daylight	Throat	Table Height	Machine Dimensions			Speed			Oil tank	Weight	Main motor
	A	B	C	J	D	E	Length x Width x Height (L x W x H)			Approach Speed	Return Speed	Bending Speed	Lt	kg	kW
	mm	mm	mm	mm	mm	mm	mm			mm/s	mm/s	mm/s			
D100	2600	2150	410	615	510	890	4220	2230	3050	200	135	10	180	7150	7,5
	3100	2600	410	615	510	905	4670	2230	3050	200	135	10	180	7500	7,5
D135	3100	2600	410	615	510	935	5300	2815	3100	210	130	10	180	8950	11
	3700	3200	410	615	510	945	5900	2815	3100	210	130	10	180	10600	11
D175	4100	3600	410	615	510	945	6300	2815	3100	210	130	10	180	11350	11
	3100	2600	410	615	510	935	5300	2775	3155	180	130	10	180	10300	15
D220	3700	3200	410	615	510	945	5900	2775	3155	180	130	10	180	11950	15
	4100	3600	410	615	510	945	6300	2775	3155	180	130	10	180	12650	15
	3100	2600	410	615	510	965	5300	2795	3250	180	140	10	290	12050	18,5
D270	3700	3200	410	615	510	965	5900	2795	3250	180	140	10	290	13600	18,5
	4100	3600	410	615	510	965	6300	2795	3250	180	140	10	290	14600	18,5
	5100	4200	410	615	510	995	7300	2795	3300	180	140	10	290	17600	18,5
	6100	5100	410	615	510	995	8300	2795	3300	180	140	10	290	22300	18,5
	3100	2600	410	615	510	950	5300	2765	3250	150	120	10	290	14150	22
D320	3700	3200	410	615	510	955	5900	2765	3250	150	120	10	290	15350	22
	4100	3600	410	615	510	955	6300	2765	3250	150	120	10	290	16350	22
	3100	2600	410	635	510	960	5300	2755	3250	150	110	10	290	15800	22
D400	3700	3200	410	635	510	960	5900	2755	3250	150	110	10	290	16600	22
	4100	3600	410	635	510	1010	6300	2765	3350	150	110	10	290	17900	22
	5100	4200	410	635	510	1025	7300	2785	3350	150	110	10	290	22600	22
	6100	5100	410	635	510	1055	8300	2785	3350	150	110	10	290	27100	22
	3100	2600	410	635	510	1015	5300	2775	3600	100	80	8	400	19800	30
	3700	3200	410	635	510	975	5900	2775	3600	100	80	8	400	22000	30
D500	4100	3600	410	635	510	975	6300	2790	3600	100	80	8	400	23850	30
	5100	4200	410	635	510	975	7300	2790	3600	100	80	8	400	26650	30
	6100	5100	410	635	510	1055	8300	2790	3730	100	80	8	400	34000	30
	8100	7100	410	635	510	815	10150	2790	3750	100	80	8	400	46000	30
	3700	3200	410	635	510	1025	5900	2730	3625	80	70	8	500	25500	37
	4100	3600	410	635	510	1025	6300	2740	3625	80	70	8	500	27950	37
D600	5100	4200	410	635	510	1055	7300	2755	3650	80	70	8	500	31500	37
	6100	5100	410	635	510	965	8200	3150	3900	80	70	8	500	41000	37
	8100	7100	410	635	510	750	10200	3200	3950	80	70	8	500	57000	37
D800	4100	3200	410	675	610	995	6300	3125	4050	80	80	8,5	550	34000	45
	5100	4200	410	675	610	995	7300	3260	4050	80	80	8,5	550	37000	45
	6100	5100	410	675	610	995	8350	3260	4050	80	80	8,5	550	49000	45
	8100	7100	410	675	610	750	10300	3250	4050	80	80	8,5	550	68000	45
D1000	4100	3200	410	675	610	750	6300	3200	4150	75	70	6	780	44000	45
	6100	5100	410	675	610	750	8300	3250	4150	75	70	6	780	62000	45
	8100	7100	410	675	610	750	10500	3250	4150	75	70	6	780	87000	45
D1250	4100	3200	510	775	610	750	6400	3650	4150	70	65	6	1000	70000	45
	6100	5100	510	775	610	750	8400	3650	4350	70	65	6	1000	76000	45
	8100	7100	510	775	610	750	10500	3650	4750	70	65	6	1000	105000	45
D1500	6100	5000	510	775	610	750	8500	3650	4850	70	55	6	1000	92000	55
	8100	7100	510	775	610	750	10600	3650	4850	70	55	6	1000	130000	55
D2000	6100	5000	510	775	610	750	8600	3900	4950	70	55	6	1300	111000	75
	8100	6500	510	775	610	750	10700	3900	4950	70	55	6	1300	153000	75
D2200	6100	4500	510	775	610	750	8600	4050	5050	70	60	5	1700	152000	90
	8100	6500	510	775	610	750	10700	4050	5050	70	60	5	1700	210000	90

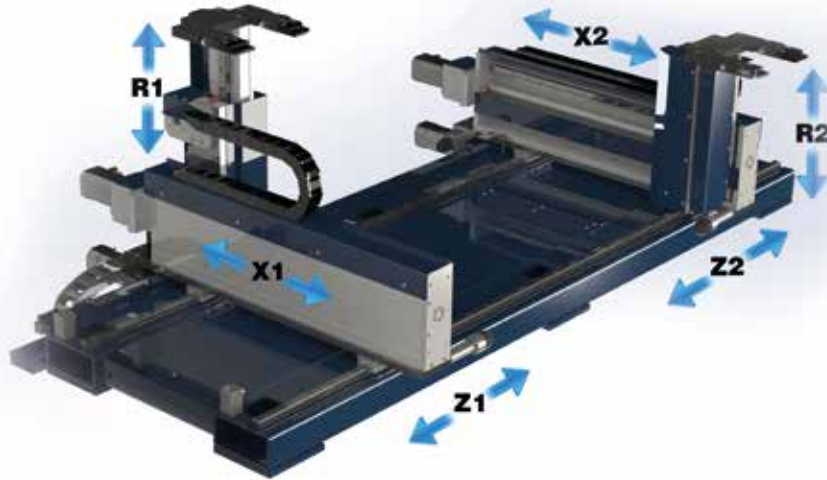

510 mm Throat

Stroke
410 mm

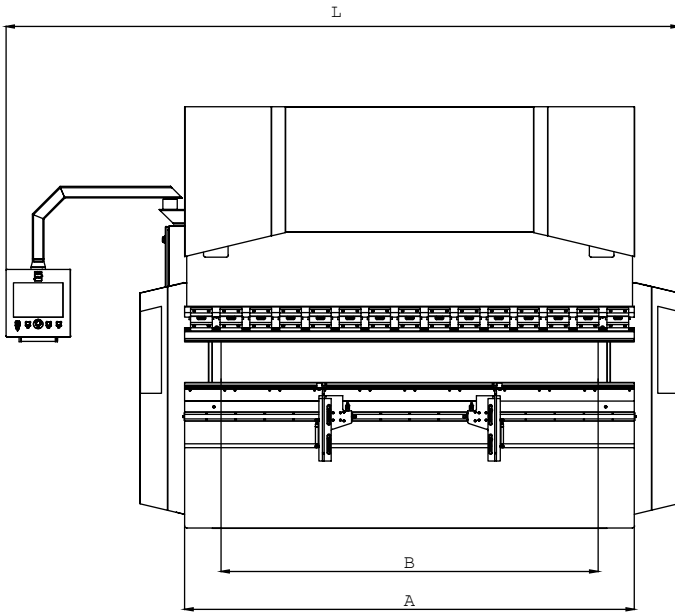
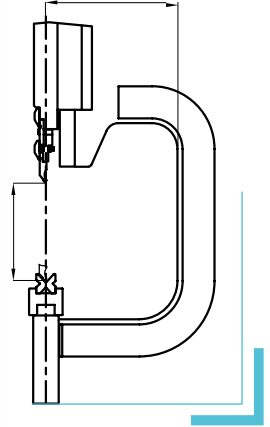

Front view

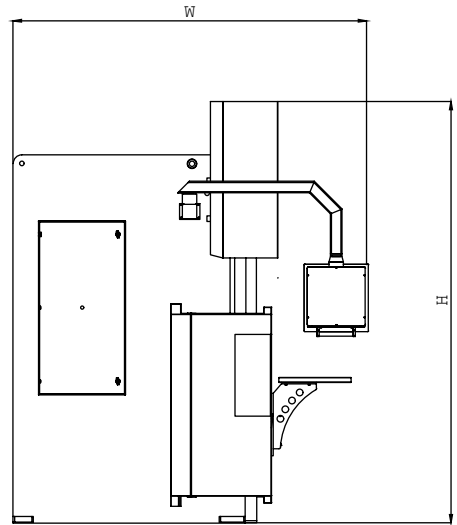

Side view

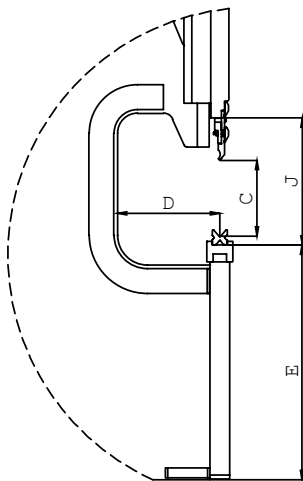

Work zone detail

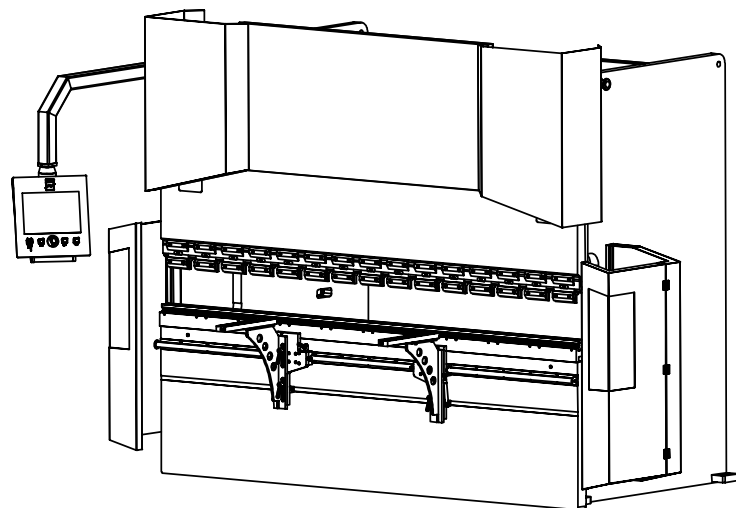

Perspective view